

LX-PA SERIES

RATIOMETRIC VOLTAGE



The **UniMeasure LX-PA Series** linear position transducer with analog output is a low cost, compact alternative for use in light to moderate duty applications in dry environments. The plastic bodied device is ideal for high volume OEM situations where cost is a major consideration and in applications where small size or low weight are of paramount importance.

Model LX-PA is available in eleven different measurement ranges with a maximum range of 50" (1250 mm). The output is voltage from a potentiometric voltage divider circuit. In standard form, the electrical connections are made directly to the contacts on the potentiometer of the unit. Optional electrical cable attached to the potentiometer is available in various lengths. Standard potentiometer value is 1K ohm with optional values of 2K, 5K and 10K ohm available.

SPECIFICATIONS

General

- Measurement Ranges..... See Table 1
- Sensing Device Precision Potentiometer
- Resolution Essentially Infinite
- Linearity
- 2", 2.8", 3.8" 4.7" ranges..... ±1.0% Full Scale
- 10" to 25" ranges ±0.5% Full Scale
- 30" to 50" ranges ±0.25% Full Scale
- Repeatability ±0.03% Full Scale
- Construction Thermoplastic Body
- Cable..... Ø.018 (0.46 mm) Jacketed
- Stainless Steel
- Wire Rope Tension See Table 1
- Weight 3 oz. (85 gm)
- Connections Solder terminals
- Dimensional Information See Supplemental Data¹
- Life
- Ranges to 4.7" 1,000,000 full stroke cycles
- Ranges 10" to 25" 250,000 full stroke cycles
- Ranges 30" to 50" 125,000 full stroke cycles

Electrical

- Input Impedance..... 1000 Ω ±15%
- Output Impedance..... 0 to 1000 Ω
- Excitation Voltage (Ve)..... 25 Volts max. AC or DC

Environmental

- Operating Temperature..... -25°C to 75°C
- Storage Temperature -50°C to 80°C
- Operating Humidity..... 95 R.H. max. non-condensing
- Vibration 15 G's 0.1 ms max.
- Shock..... 50 G's 0.1 ms max.
- Ingress Protection NEMA 1, IP-40

TABLE 1

MODEL	RANGE		NOMINAL OUTPUT		NOMINAL WIRE ROPE TENSION	
	(inch)	(mm)	(mV/in/Ve)	(mV/mm/Ve)	(oz)	(N)
LX-PA-2	2	50	469	18.5	16	4.4
LX-PA-2.8	2.8	70	341	13.4	14	3.9
LX-PA-3.8	3.8	96	258	10.1	11	3.1
LX-PA-4.7	4.7	120	207	8.1	8	2.2
LX-PA-10	10	250	88	3.5	16	4.4
LX-PA-15	15	380	64	2.5	14	3.9
LX-PA-20	20	500	49	1.9	11	3.1
LX-PA-25	25	625	39	1.5	8	2.2
LX-PA-30	30	750	32	1.3	14	3.9
LX-PA-40	40	1000	24	1.0	11	3.1
LX-PA-50	50	1250	20	0.8	8	2.2

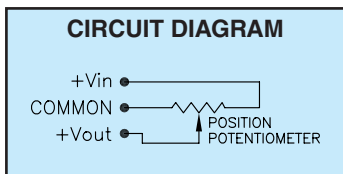

FOOTNOTES TO SPECIFICATIONS
1. Supplemental Data section located at end of LX Series pages.

Model Number Configuration

LX-PA- - - -

Range	
2	2.0" (50 mm)
2.8	2.8" (70 mm)
3.8	3.8" (96 mm)
4.7	4.7" (120 mm)
10	10" (250 mm)
15	15" (390 mm)
20	20" (500 mm)
25	25" (640 mm)
30	30" (750 mm)
40	40" (1000 mm)
50	50" (1250 mm)

Potentiometer Value	
*	1K ohm
P2K	2K ohm
P5K	5K ohm
P10K	10K ohm

Electrical Cable Length	
*	No Electrical Cable
LPM	150 mm (6") pigtail
L1M	1 m (3')
L2M	2 m (6.5')
L3M	3 m (10')
L4M	4 m (13.5')
L5M	5 m (16.5')

Connector	
*	No Connector
C	Cable to Cable Connector with Mating Connector
K	Cable to Cable Connector with NO Mating Connector

For option "K", electrical cable with mating connector may be ordered separately as item number **10248-xM**, where "x" is the required length in meters.

1. "C" and "K" options only apply when electrical cable is selected.
2. Cable to cable connector does not connect cable shield/drain wire.

NOTE
1) *—Asterisk items are standard configuration. No option designator is required.
2) Shaded options available at additional cost.

Example
LX-PA-20-L1M

DIMENSIONAL INFORMATION

LX-PA

RANGE	Dim "A"	
	(inch)	(mm)
2", 10"	1.01	25.7
2.8", 15", 30"	1.14	29.0
3.8", 20", 40"	1.30	33.0
4.7", 25", 50"	1.46	37.1

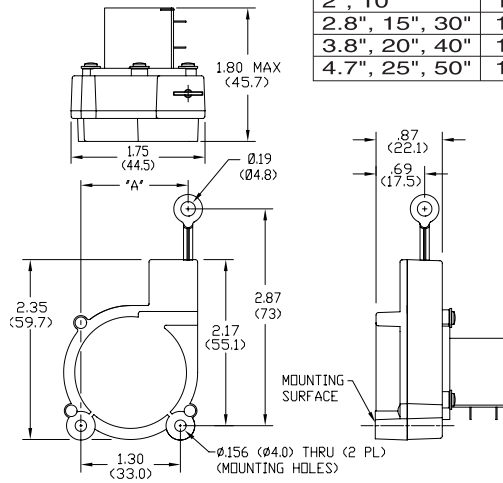

Dimensions in brackets are millimeters

ACCESSORY—10346 RIGHT ANGLE MOUNTING BRACKET

The Right Angle Mounting Bracket serves as a base for mounting the LX transducer perpendicular to a surface. The transducer may be mounted in any of four different wire rope exit orientations when mounted on the outside of the bracket (see figure) or any of three orientations when placed above the bracket mounting holes. Order model number: **10346**.

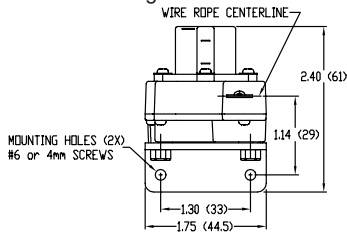

10346 Right Angle Mounting Bracket

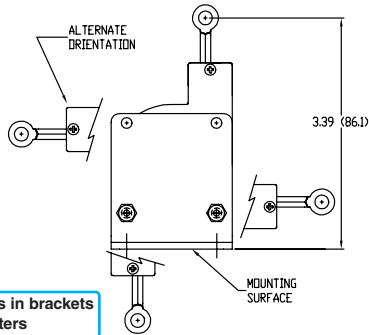

With Transducer Mounted

Dimensions in brackets are millimeters

ACCESSORY—10156 TWO AXIS SWIVEL BASE

With a capability of 360° rotation about the vertical axis and 245° rotation about the horizontal axis, the 10156 Two Axis Swivel Base allows easy setup of the LX-PA or the LX-EP transducer. The axes may be locked in place after the transducer is oriented. Ideal for quick setups. Order model number: **10156**.

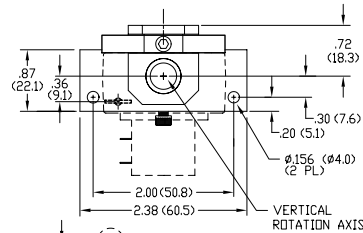

10156 Two Axis Swivel Base

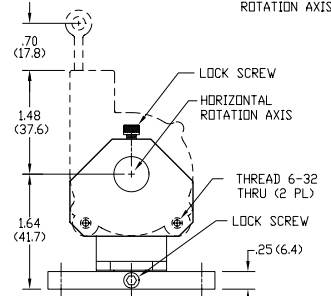

With Transducer Mounted

Dimensions in brackets are millimeters

ACCESSORY—10067 AUXILIARY WIRE ROPE EXTENSION KIT

The auxiliary wire rope extension may be used to facilitate mounting the transducer remotely from the measurement point. The clip on the extension attaches to the eye fitting on the transducer. The eye fitting on the opposite end, which is identical to the fitting on the transducer, mounts to the moving element. The extension kit is also available with the clip end unterminated for situations where it is more convenient to size the wire rope length during installation. Clip and crimp fitting are included with the unterminated version.

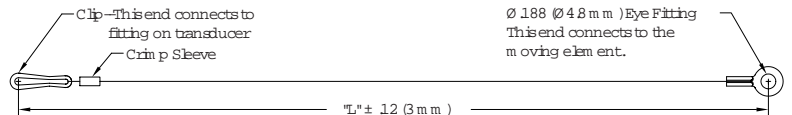

10067- CM-

Dimension "L"
Specify dimension "L" in centimeters to the nearest whole centimeter.

Note 1. 1 cm = 0.394", 1 inch = 2.54 cm
Note 2. Shortest length "L" is 5 cm (approximately 2").

*..... Completed kit (no designator required)
U..... Unterminated clip end (clip and crimp sleeve included in kit)

* Leave blank. No designator required.